

B) PANNELLO di RINFORZO
(da posizionare sul retro
del pannello C)

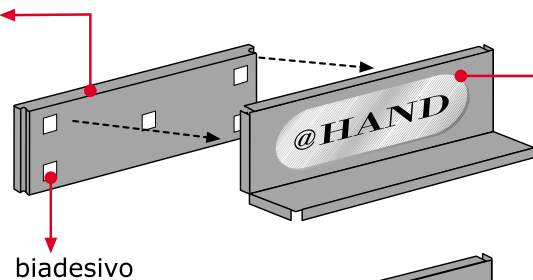

C) PANNELLO FRONTALE
(con logo @HAND)

L) PORTA
CATALOGHI

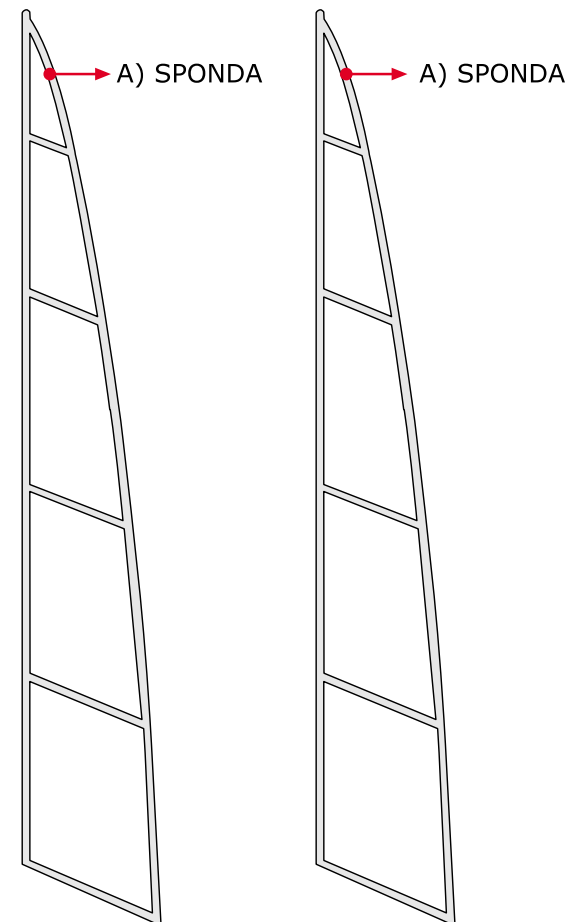

(non c'è differenza fra dx e sx)

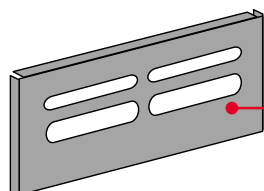

D) PANNELLO ASOLATO
(per accessori)

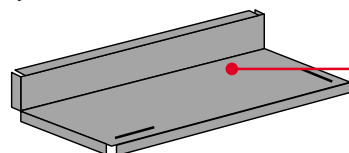

E) PIANO con SPONDA
(con 2 fessure per
portacataloghi)

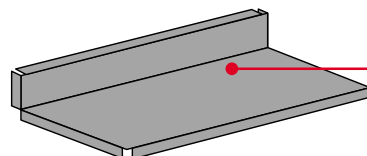

F) PIANO con SPONDA

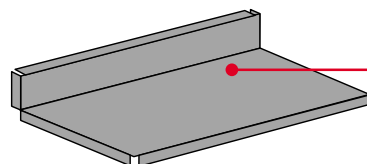

G) PIANO con SPONDA

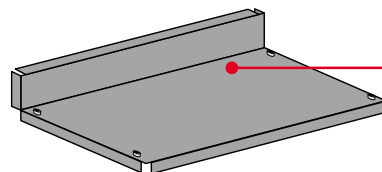

H) FONDO con SPONDA
(con fori per ruote)

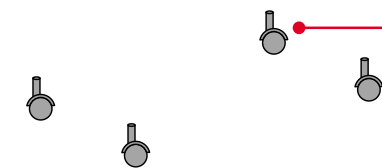

I) RUOTE
(4 pezzi)

ESPOSITORE COMPLETO

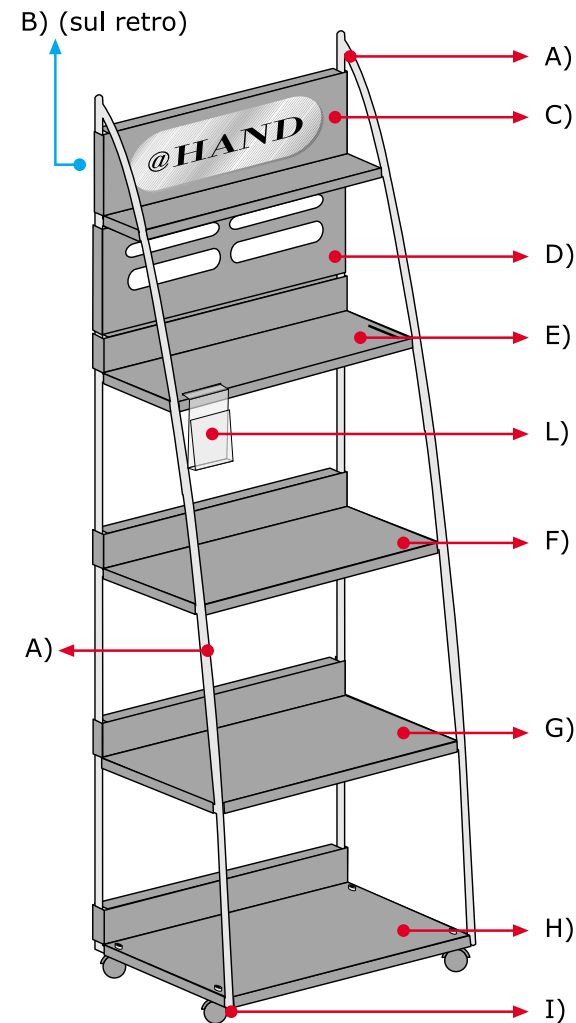

**CONSIGLIO PER UN VELOCE E CORRETTO
INSERIMENTO DEI RIPIANI:
INCASTRARE, FINO A BATTUTA, PRIMA LA
PARTE ANTERIORE DEI RIPIANI E POI
QUELLA POSTERIORE**